



Instrumente si solutii de masurare TESA
Perfectiune pana la detaliu pentru orice utilizator

Valid pana la 31.12.2017
Preturi fara TVA
Versiune RO – EUR

TESA MICROHITE

Motorizată sau manuală – Referința finală

Cu panou de comandă hibrid, ajustabil pentru mai mulți utilizatori (touch screen + tastatură)



Certificat SCS inclus: Instrumentul este pregătit pentru utilizare imediată.



Determinare eficientă a punctului de maxim / minim prin aprinderea LED-ului de control





<http://go.hexagonmi.com/MICRO-HITEvideo>

NOU!

Securitate datorată înaltelor standarde de calitate și 4 ani garanție pentru noile modele TESA MICRO-HITE



Warranty conditions on our website

In sfârșit, măsurare 2D simplă printr-o vizualizare grafică clară

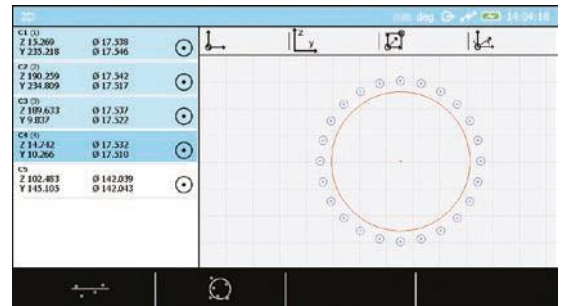

Ajutor bazat pe context – ghid inteligent pentru operator

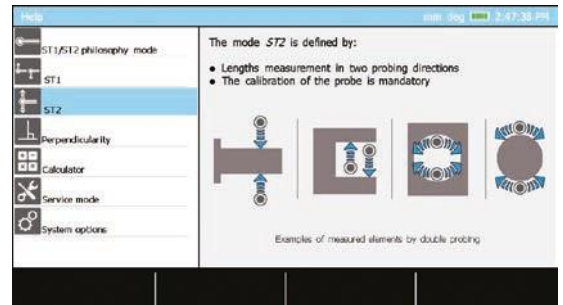

Transferul ușor al datelor la stick USB / imprimantă / PC

NOU!

Generarea unui raport de măsurători în format pdf direct din program.

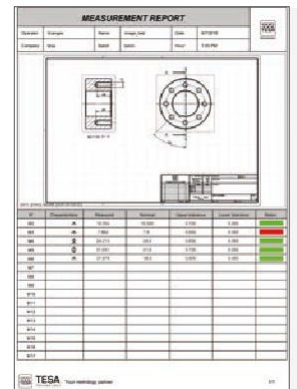

Cod	Descriere	Pret lista (€)
00730073	MICRO-HITE 350 manuală	6100
00730074	MICRO-HITE 600 manuală	6600
00730075	MICRO-HITE 900 manuală	9500
00730076	MICRO-HITE 350F manuală, ajustare fină	6450
00730077	MICRO-HITE 600F manuală, ajustare fină	6950
00730078	MICRO-HITE 900F manuală, ajustare fină	9850
00730079	MICRO-HITE+M 350 motorizată	6100
00730080	MICRO-HITE+M 600 motorizată	6600
00730081	MICRO-HITE+M 900 motorizată	9500
00760235	Imprimantă USB MICRO-HITE	391

Compatibil cu



TESA-HITE MAGNA COLOANA DE MĂSURARE PENTRU CONDIȚII DURE

Coloană de măsurare simplu de utilizat proiectată pentru măsurători 1D rapide și fiabile



2359€

2799€



Cod	Descriere	Domeniu de masurare (mm)	Erori maxime admise (µm)	Repeatabilitate limita(µm)	Pret de lista (€)	Pret Promo (€)
00730047	TESA-HITE magna 400	0 ÷ 570	< 8	On flat: 2 = < 3 Into bore: 2 = < 5	2930	2359
00730059	TESA-HITE magna 700	0 ÷ 870	< 8	On flat: 2 = < 3 Into bore: 2 = < 5	3443	2799



SISTEM TESA TWIN-CAL

Cu ieşire de date integrată și afişaj mare pentru o citire clară a rezultatelor

Cod	Descriere	Domeniu de măsurare (mm)	Rola de avans fin	Tijă de adancime	Pret lista (€)	Pret Promo (€)
00530319	TWIN-CAL IP67	0 ÷ 150	=	■	159	119
00530320	TWIN-CAL IP67	0 ÷ 150	●	●	159	119
00530321	TWIN-CAL IP67	0 ÷ 150	✓	●	159	119
00530322	TWIN-CAL IP67	0 ÷ 200	✓	■	222	175
00530323	TWIN-CAL IP67	0 ÷ 300	✓	■	305	235
00530094	TWIN-CAL	0 ÷ 150	✓	●	109	79
00530097	TWIN-CAL	0 ÷ 150	–	■	109	79
00530095	TWIN-CAL	0 ÷ 200	✓	■	156	125
00530096	TWIN-CAL	0 ÷ 300	✓	■	219	175



NOU!
Colectarea datelor este posibilă acum cu Q-DAS



SET 31 SI SET 22 TESA μ-FINDER

Set mobil de inalta precizie pentru control de calitate si service, intr-o geanta de transport practica.

1699€



04430013P1

1379€



04430013P2



Cod	Descriere	Pret lista (€)	Pret Promo (€)
04430013P1	TESA μFinder Set 31	2144	1699
Contine:			
04430013	Unitate de afisaj TESA TWIN-T10		
03210802	Palpator inductiv lateral GT 31		
01639007	Suport magnetic INTERAPID UJ15		

04430013P2	TESA μFinder Set 22	1755	1379
Contine:			
04430013	Unitate de afisaj TESA TWIN-T10		
03210924	Palpator inductiv GT 22		
01639007	Suport magnetic INTERAPID UJ15		

Cod	Descriere	Pret lista (€)	Pret Promo (€)
04430013	Unitate de afisaj TESA TWIN-T10	1217	1022
03210802	Palpator inductiv lateral GT 31 ± 0,3 mm	763	689
03210904	Palpator inductiv GT 21 ± 1,0 mm	338	299
03210924	Palpator inductiv GT 22 ± 1,0 mm	349	309
01639007	Suport magnetic INTERAPID UJ15	139	115



03210802



03210924



03210904



01639007



04430013

SISTEM TESA IMICRO CAPA μ CU AFISAJ DIGITAL

Combinarea cu succes a sistemului capacitiv patentat TESA cu conul unic IMICRO.

Sunt atractive in special seturile pentru atelier.



De la
1799€

06130233

Cod	Domeniu de masurare (mm)	Numar Capete de masurare	Domeniu de masurare (mm)	Numar inele de calibrare	Diametru (mm)	Extensii	Lungime (mm)	Pret lista (€)	Pret Promo (€)
Contine:									
06130231	6 ÷ 12	06140024	6 ÷ 8	00840101	8	00840001	100	2178	1799
		06140025	8 ÷ 10	00840102	10				
		06140026	10 ÷ 12						
06130232	11 ÷ 20	06140027	11 ÷ 14	00840103	11	00840301	150	2335	1929
		06140028	14 ÷ 17	00840104	15				
		06140029	17 ÷ 20						
06130233	20 ÷ 40	06140030	20 ÷ 25	00840106	25	00841100	150	3068	2499
		06140031	25 ÷ 30	00840107	35				
		06140032	30 ÷ 35						
		06140033	35 ÷ 40						
06130234	40 ÷ 100	06140034	40 ÷ 50	00840108	50	00841800	150	5637	4699
		06140035	50 ÷ 60	00840109	70				
		06140036	60 ÷ 70	00840110	90				
		06140037	70 ÷ 80						
		06140038	80 ÷ 90						
		06140039	90 ÷ 100						

Alti fabricanti

Influenta variatiei temperaturii la micrometrele de interior produse de alti fabricanti

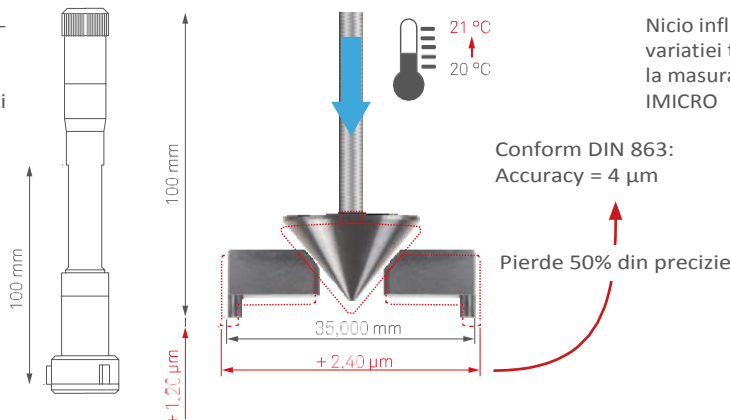

TESA IMICRO

Nicio influenta a variatiei temperaturii la masurarea cu TESA IMICRO

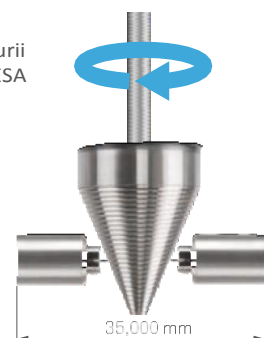

TESATAST – INALTA PRECIZIE SI FORTA DE MASURARE FOARTE MICA A MECANISMULUI CU 7 RUBINE

Durabilitatea datorata sistemului patentat de protectie la soc; insensibil la campurile magnetice



90€

Cod	Domeniu de masurare (mm)	Diviziune (mm)	Diametru cadran (Ø mm)	Pret lista (€)	Pret Promo (€)
01810005	0,8	0,01	28	113	90
01810006	0,8	0,01	38	127	99
01810007	0,5	0,01	28	147	118
01810008	0,5	0,01	38	162	130
01810009	0,2	0,002	28	133	106
01810010	0,2	0,002	38	147	118
S18001695	0,2	0,001	38	169	118

Cod	Descriere	Pret lista (€)	Pret Promo (€)
01639055	Mini-Set: Suport magnetic + Suport magnetic TESATAST 01810005	162	125



125€

01639055

ACCESORII CARE GAREANTEAZA MASURATORI CORECTE

Cod	Descriere	Pret lista (€)	Pret Promo (€)
01840408	Mounting Rods with Dovetail Grip ø 4 mm	26	21
01840409	Mounting Rods with Dovetail Grip ø 8 mm	26	21
01840404	Short swivel holder	44	36
01840501	Centering holder	107	88
01840407	Long swivel holder with fine adjustment	87	72



<http://go.hexagonmi.com/TESATAST>



01840409



01840408

01840407

01840404



01840501

PORTABIL – ROBUST – SIMPLU DE UTILIZAT - 15 dintre cei mai folositi parametri de rugozitate

Cod	Descriere	Pret lista (€)	Pret Promo (€)
06930013	TESA RUGOSURF 20	1920	1499
06960034	Software RUGOSOFT	530	399
06960056	Extensie 100mm pentru palpator	430	345
04760099	Cablu PC - RUGOSURF 20	22	22

NOU!
Design

NOU!
Varf de palpare
cu raza
de 2µm



Se livreaza cu standard de rugozitate de 2,97µm

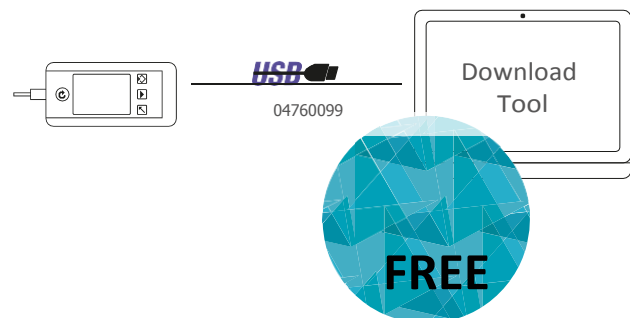

Descarcarea si imprimarea rezultatelor
NOU! Descarcare gratuita a uneltei Data Connection



<http://go.HexagonMI.com/DataConnectionTool>

RUGOSURF ARE NEVOIE DE INLOCUIREA PALPATORULUI ?

Inlocuirea cu un palpator reconditionat pentru un cost convenabil - disponibil in stoc
Contact office@procontrol-amc.ro

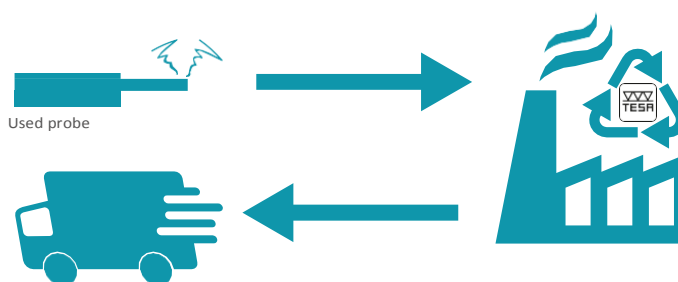

PROCONTROL AMC srl

APARATE DE MASURAT SI CONTROL

Str. Caporal Ghe Ion nr. 4, Sector 4, Bucuresti, RO-041974, Romania, J40 / 987 / 2004, CF: R 16080995
Tel / Fax: 0040 21 208 96 79

E-mail: office@procontrol-amc.ro www.procontrol-amc.ro